



# RAV4 Hybrid

**2WD / 4WD-AWD**

*Gasoline-Electric*

*Hybrid Synergy Drive*

***HYBRID VEHICLE  
DISMANTLING  
MANUAL***



## Foreword

This guide was developed to educate and assist dismantlers in the safe handling of Toyota RAV4 Hybrid gasoline-electric hybrid vehicles. RAV4 Hybrid dismantling procedures are similar to other non-hybrid Toyota vehicles with the exception of the high voltage electrical system. It is important to recognize and understand the high voltage electrical system features and specifications of the Toyota RAV4 Hybrid, as they may not be familiar to dismantlers.

High voltage electricity powers the A/C compressor, electric motors, generator, and inverter/converter. All other conventional automotive electrical devices such as the head lights, radio, and gauges are powered from a separate 12 V auxiliary battery. Numerous safeguards have been designed into the RAV4 Hybrid to help ensure the high voltage, approximately 244.8 V, Nickel Metal Hydride (NiMH) Hybrid Vehicle (HV) battery pack is kept safe and secure in an accident.

The NiMH HV battery pack contains sealed batteries that are similar to rechargeable batteries used in some battery operated power tools and other consumer products. The electrolyte is absorbed in the cell plates and will not normally leak out even if the battery is cracked. In the unlikely event the electrolyte does leak, it can be easily neutralized with a dilute boric acid solution or vinegar.

High voltage cables, identifiable by orange insulation and connectors, are isolated from the metal chassis of the vehicle.

Additional topics contained in the guide include:

- Toyota RAV4 Hybrid identification.
- Major hybrid component locations and descriptions.

By following the information in this guide, dismantlers will be able to handle RAV4 Hybrid hybrid-electric vehicles as safely as the dismantling of a conventional gasoline engine automobile.

© 2019 Toyota Motor Corporation

All rights reserved. This book may not be reproduced or copied, in whole or in part, without the written permission of Toyota Motor Corporation.

## Table of Contents

<b><u>About the RAV4 Hybrid</u></b> .....	<b><u>1</u></b>
<b><u>RAV4 Hybrid Identification</u></b> .....	<b><u>2</u></b>
<b><u>RAV4 Hybrid Identification (Continued)</u></b> .....	<b><u>3</u></b>
<u>Exterior</u> .....	<u>3</u>
<u>Interior</u> .....	<u>4</u>
<u>Engine Compartment</u> .....	<u>5</u>
<b><u>Hybrid Component Locations &amp; Descriptions</u></b> .....	<b><u>6</u></b>
<b><u>Hybrid Component Locations &amp; Descriptions (Continued)</u></b> .....	<b><u>7</u></b>
<u>Specifications</u> .....	<u>7</u>
<b><u>Hybrid Synergy Drive Operation</u></b> .....	<b><u>8</u></b>
<u>Vehicle Operation</u> .....	<u>8</u>
<b><u>Hybrid Vehicle (HV) Battery Pack and Auxiliary Battery</u></b> .....	<b><u>9</u></b>
<u>HV Battery Pack</u> .....	<u>9</u>
<u>Components Powered by the HV Battery Pack</u> .....	<u>9</u>
<b><u>Hybrid Vehicle (HV) Battery Pack and Auxiliary Battery (Continued)</u></b> .....	<b><u>10</u></b>
<u>HV Battery Pack Recycling</u> .....	<u>10</u>
<u>Auxiliary Battery</u> .....	<u>10</u>
<b><u>High Voltage Safety</u></b> .....	<b><u>11</u></b>
<u>High Voltage Safety System</u> .....	<u>11</u>
<b><u>High Voltage Safety (Continued)</u></b> .....	<b><u>12</u></b>
<u>Service Plug Grip</u> .....	<u>12</u>
<b><u>Precaution to be observed when dismantling the vehicle</u></b> .....	<b><u>13</u></b>
<u>Necessary Items</u> .....	<u>13</u>
<b><u>Spills</u></b> .....	<b><u>14</u></b>
<b><u>Dismantling the vehicle</u></b> .....	<b><u>15</u></b>
<b><u>Removal of HV battery</u></b> .....	<b><u>20</u></b>



## About the RAV4 Hybrid

The RAV4 Hybrid 5-door wagon joins the hybrid model for Toyota. Hybrid Synergy Drive means that the vehicle contains a gasoline engine and two electric motors for power.

The two hybrid power sources are stored on board the vehicle:

1. Gasoline stored in the fuel tank for the gasoline engine.
2. Electricity stored in a high voltage Hybrid Vehicle (HV) battery pack for the electric motors.

The result of combining these two power sources is improved fuel economy and reduced emissions. The gasoline engine also powers an electric generator to recharge the battery pack; unlike a pure all electric vehicle, the RAV4 Hybrid never needs to be recharged from an external electric power source.

Depending on the driving conditions one or both sources are used to power the vehicle. The following illustration demonstrates how the RAV4 Hybrid operates in various driving modes.

- ❶ During light acceleration at low speeds, the vehicle is powered by the electric motors. The gasoline engine is shut off.
- ❷ During normal driving, the vehicle is powered mainly by the gasoline engine. The gasoline engine also powers the generator to recharge the battery pack and to drive the motors.
- ❸ During full acceleration, such as climbing a hill, both the gasoline engine and the electric motors power the vehicle.
- ❹ During deceleration, such as when braking, the vehicle regenerates the kinetic energy from the front wheel to produce electricity that recharges the battery pack.
- ❺ While the vehicle is stopped, the gasoline engine and electric motors are off, however the vehicle remains on and operational.

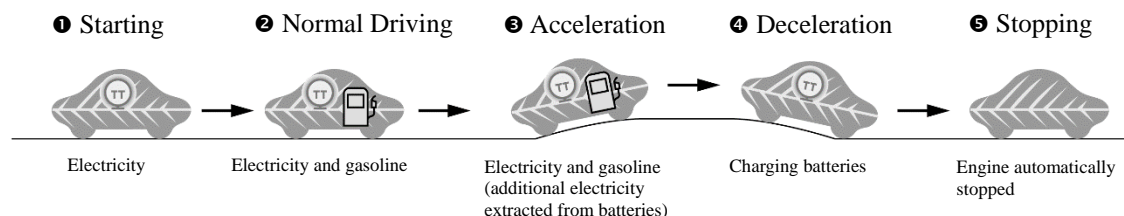

## RAV4 Hybrid Identification

In appearance, the 2020 model year RAV4 Hybrid is nearly identical to the conventional, non-hybrid Toyota RAV4. The RAV4 Hybrid is a 5-door wagon. Exterior, interior, and engine compartment illustrations are provided to assist in identification.

The alphanumeric 15 character Vehicle Identification Number (VIN) is provided on the left side windshield cowl, floor under the right side front seat and left side B pillar.

Example VIN:

<u>JTMBW3FV</u> D002001	<u>JTMRW3FV</u> D002001
<u>JTMDW3FV</u> D002001	<u>JTMZ23FV</u> D002001
<u>JTMW23FV</u> D002001	<u>JTMY23FV</u> D002001
<u>JTMBWRFV</u> D002001	<u>JTMRWRFV</u> D002001
<u>JTMDWRFV</u> D002001	<u>JTMW2RFV</u> D002001

A RAV4 Hybrid is identified by the first 8 alphanumeric characters.

<b>JTMBW3FV</b>	<b>JTMRW3FV</b>
<b>JTMDW3FV</b>	<b>JTMZ23FV</b>
<b>JTMW23FV</b>	<b>JTMY23FV</b>
<b>JTMBWRFV</b>	<b>JTMRWRFV</b>
<b>JTMDWRFV</b>	<b>JTMW2RFV</b>

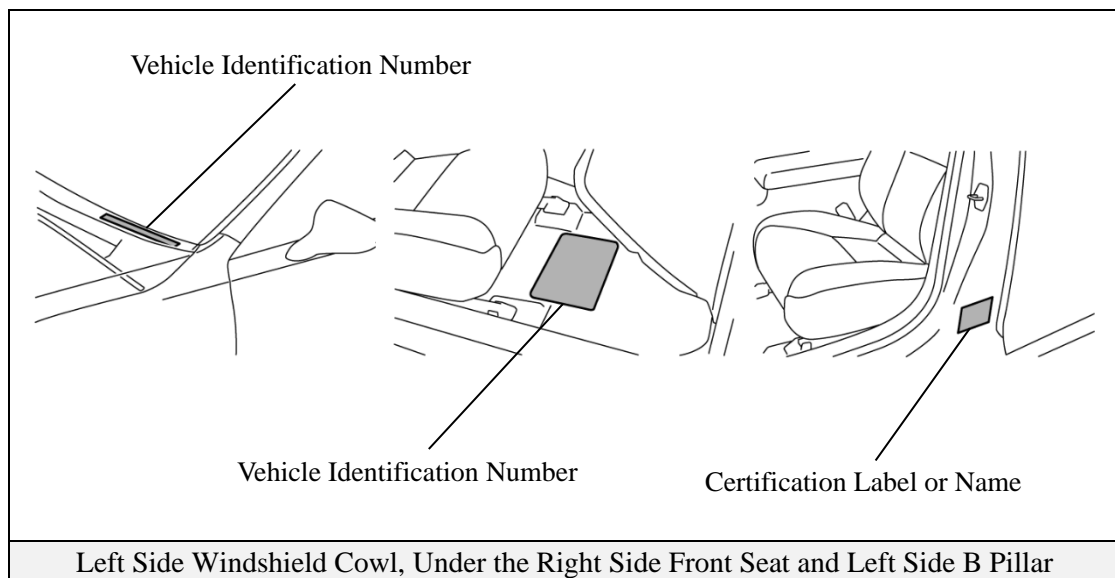

## RAV4 Hybrid Identification (Continued)

### Exterior

- 1 **HYBRID** logos on the back door and each front fender.
- 2 Gasoline fuel filler door located on left side rear quarter panel.



Exterior Front and Left Side View



Exterior Rear and Left Side View

## RAV4 Hybrid Identification (Continued)

### Interior

- ③ The instrument cluster (hybrid system indicator, **READY** indicator and warning lights) located in the dash behind the steering wheel, is different than the one on the conventional, non-hybrid RAV4.
- ④ In Place of a tachometer, a hybrid system indicator is used to show power output.

#### **NOTICE:**

If the vehicle is shut off, the instrument cluster gauges will be “blacked out”, not illuminated.

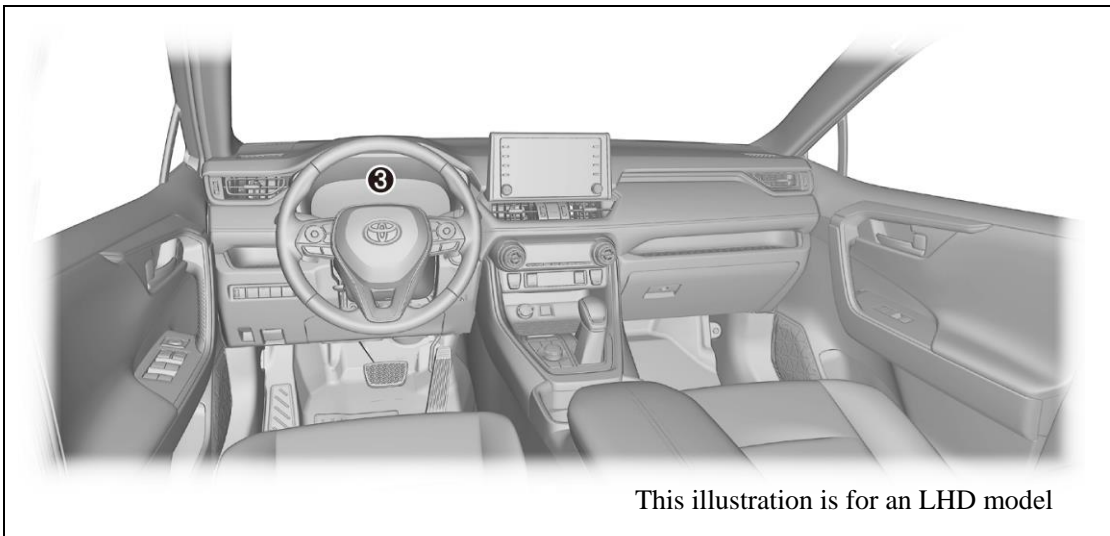

Interior View

③

<7-inch Color Display Type>

<4.2-inch Color Display Type>

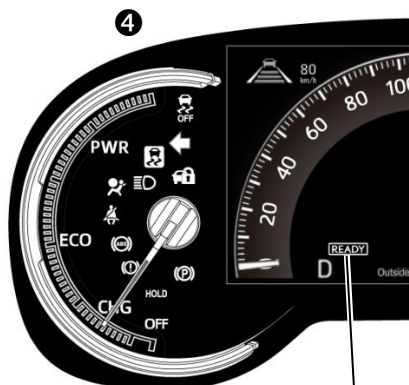

READY Indicator



READY Indicator

Combination Meter View



## RAV4 Hybrid Identification (Continued)

### Engine Compartment

- ⑤ 2.5-liter aluminum alloy gasoline engine.
- ⑥ Orange colored high voltage power cables.

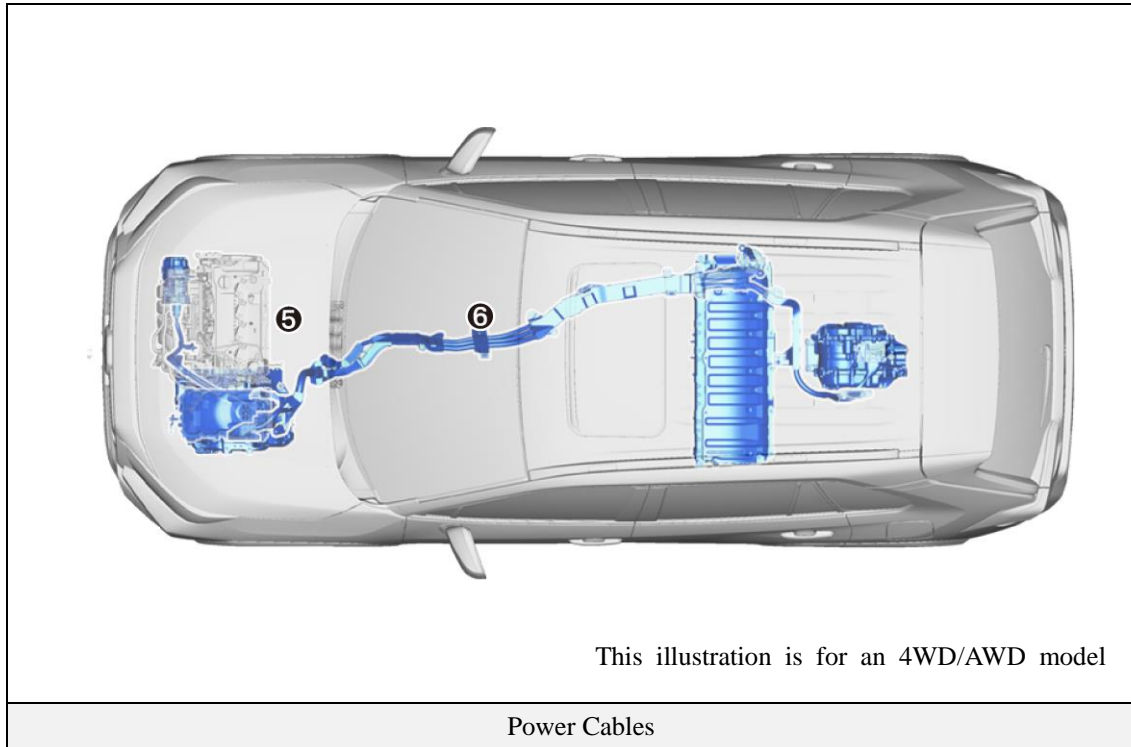

## Hybrid Component Locations & Descriptions

Component	Location	Description
12 Volts Auxiliary Battery ❶	Luggage Compartment Area	Supplies electricity to the electrical components.
Hybrid Vehicle (HV) Battery Pack ❷	Cabin Area, Mounted Under Rear Seat	<ul style="list-style-type: none"> <li>· Supplies electrical power to MG1 and MG2 in accordance with the driving conditions of the vehicle.</li> <li>· Recharged by MG1 and MG2 in accordance with the SOC and the driving conditions of the vehicle.</li> </ul>
Power Cables ❸	Undercarriage and Engine Compartment	Connects the HV battery, inverter with converter assembly, hybrid vehicle transaxle assembly and compressor with motor assembly.
Inverter/ Converter ❹	Engine Compartment	<ul style="list-style-type: none"> <li>· Converts the direct current from the boost converter into alternating current for MG1 and MG2, and vice versa (from AC to DC).</li> <li>· Boosts the HV battery nominal voltage of DC 244.8 Volts up to a maximum voltage of DC 650 Volts and vice versa (steps down DC 650 Volts to DC 244.8 Volts).</li> </ul>
Gasoline Engine ❺	Engine compartment	Provides two functions: 1) Powers vehicle. 2) Powers generator to recharge the HV battery pack. The engine is started and stopped under control of the vehicle computer.
Front Electric Motor ❻	Engine compartment	<ul style="list-style-type: none"> <li>· MG2, which is driven by electrical power from MG1 and the HV battery, generates motive force for the drive wheels.</li> <li>· During braking, or when the accelerator pedal is not depressed, it generates high-voltage electricity to recharge the HV battery.</li> </ul>
Electric Generator ❼	Engine compartment	MG1, which is driven by the engine, generates high-voltage electricity in order to operate MG2 and charge the HV battery. Also, it functions as a starter to start the engine.
A/C Compressor (with inverter) ❸	Engine compartment	3-phase high voltage AC electrically driven motor compressor.
DC-DC Converter for 12 Volts Auxiliary Battery ❾	Engine compartment	Steps down the HV battery nominal voltage of DC 244.8 Volts to approximately DC 14 Volts in order to supply electricity to the electrical components, as well as to recharge the auxiliary battery.
Rear Electric Motor ❿	Rear Sub-Frame	<ul style="list-style-type: none"> <li>· MGR, which is driven by electrical power from MG1 and the HV battery, generates motive force for the drive wheels.</li> <li>· During braking, or when the accelerator pedal is not depressed, it generates high-voltage electricity to recharge the HV battery.</li> </ul>
Fuel Tank and Fuel Line ❶	Undercarriage and Center	The fuel tank provides gasoline via a fuel line to the engine. The fuel line is routed under the center of vehicle.

\*Numbers in the component column apply to the illustrations on the following page.

## Hybrid Component Locations & Descriptions (Continued)

### Specifications

- Gasoline Engine: 131 kW, 2.5-liter Aluminum Alloy Engine
- Electric Motors
- Front: 88 kW, Permanent Magnet Motor
  - Rear: 40 kW, Permanent Magnet Motor (4WD/AWD models only)
- Transmission: Automatic Only
- HV Battery: 244.8 V Sealed NiMH-Battery
- Curb Weight: 3,627-3,800 lbs/1,645-1,724 kg
- Fuel Tank: 12.1 Imp gals/14.5 U.S. gals/55 liters
- Frame Material: Steel Unibody
- Body Material: Steel Panels
- Seating Capacity: 5 passenger

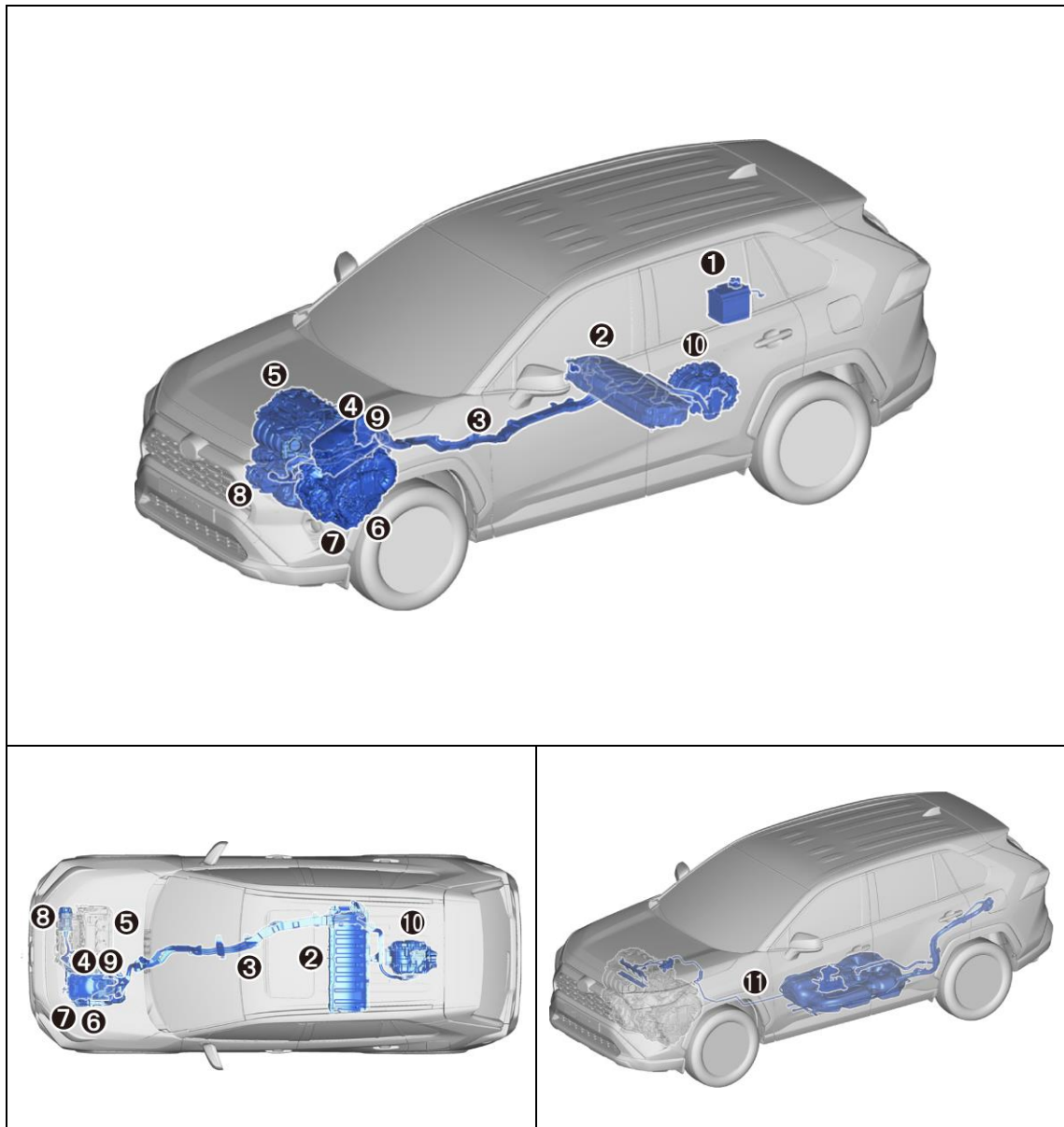

## Hybrid Synergy Drive Operation

Once the **READY** indicator is illuminated in the instrument cluster, the vehicle may be driven. However, the gasoline engine does not idle like a typical automobile and will start and stop automatically. It is important to recognize and understand the **READY** indicator provided in the instrument cluster. When illuminated, it informs the driver that the vehicle is on and operational even though the gasoline engine may be off and the engine compartment is silent.

### Vehicle Operation

- With the RAV4 Hybrid, the gasoline engine may stop and start at any time while the **READY** indicator is on.
- Never assume that the vehicle is shut off just because the engine is off. Always look for the **READY** indicator status. The vehicle is shut off when the **READY** indicator is off.

The vehicle may be powered by:

1. The electric motors only.
2. A combination of both the electric motors and the gasoline engine.

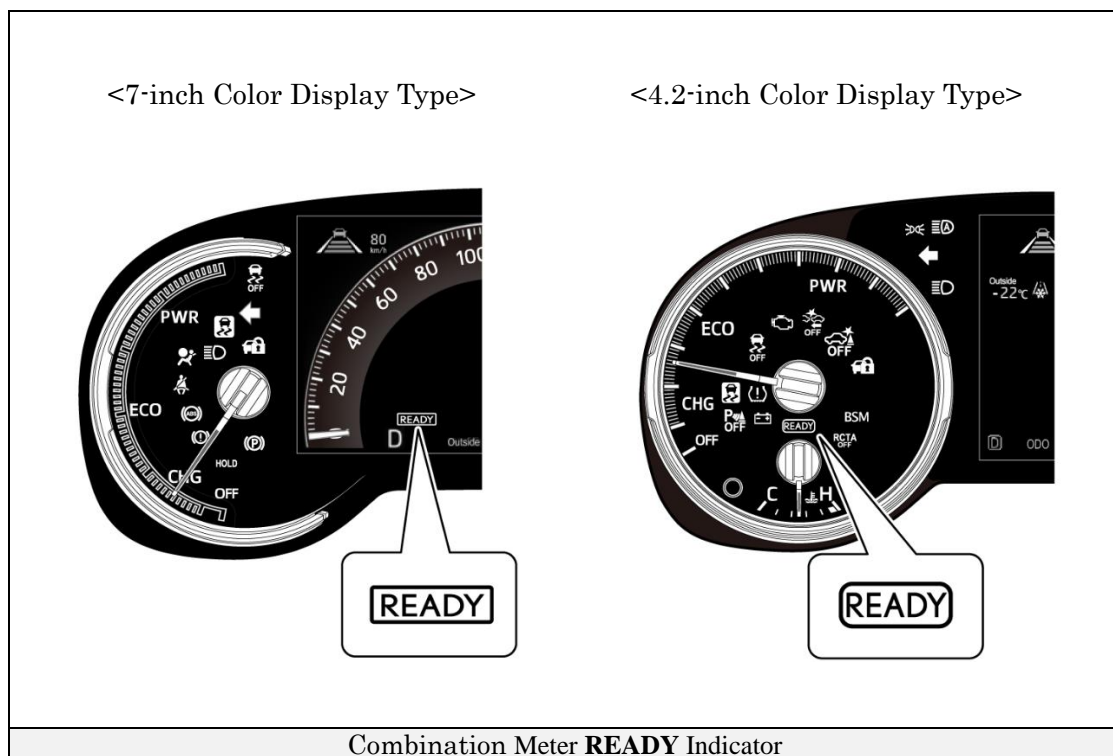

## Hybrid Vehicle (HV) Battery Pack and Auxiliary Battery

The RAV4 Hybrid features a high voltage Hybrid Vehicle (HV) battery pack that contains sealed Nickel Metal Hydride (NiMH) battery modules.

### HV Battery Pack

- The HV battery pack is enclosed in a metal case and is rigidly mounted to the cabin area under the front seats. The metal case is isolated from high voltage and concealed by fabric covers in the cabin area.
- The HV battery pack consists of 34 low voltage (7.2 Volts) NiMH battery modules connected in series to produce approximately 244.8 Volts. Each NiMH battery module is non-spillable and sealed in a metal case.
- The electrolyte used in the NiMH battery module is an alkaline mixture of potassium and sodium hydroxide. The electrolyte is absorbed into the battery cell plates and will not normally leak, even in a collision.

HV Battery Pack	
Battery pack voltage	244.8 Volts
Number of NiMH battery modules in the pack	34
NiMH battery module voltage	7.2 Volts

### Components Powered by the HV Battery Pack

- Front Electric Motor
- Rear Electric Motor (4WD/AWD models only)
- Power Cables
- A/C Compressor
- Electric Generator
- Inverter/Converter
  - DC-DC Converter for 12 Volts Auxiliary Battery

## Hybrid Vehicle (HV) Battery Pack and Auxiliary Battery (Continued)

### HV Battery Pack Recycling

- The HV battery pack is recyclable. Contact either your Toyota distributor as mentioned on the caution label on the HV battery or the nearest Toyota dealer.

### Auxiliary Battery

- The RAV4 Hybrid also contains a sealed lead-acid 12 Volts battery. This 12 Volts auxiliary battery powers the vehicle electrical system similar to a conventional vehicle. As with other conventional vehicles, the auxiliary battery is grounded to the metal chassis of the vehicle.
- The auxiliary battery is located under the luggage compartment area. It is concealed by a plastic resin cover on the right side in the battery compartment.

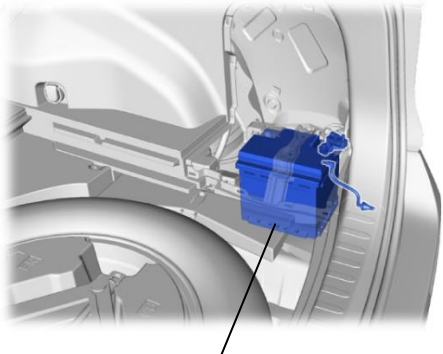
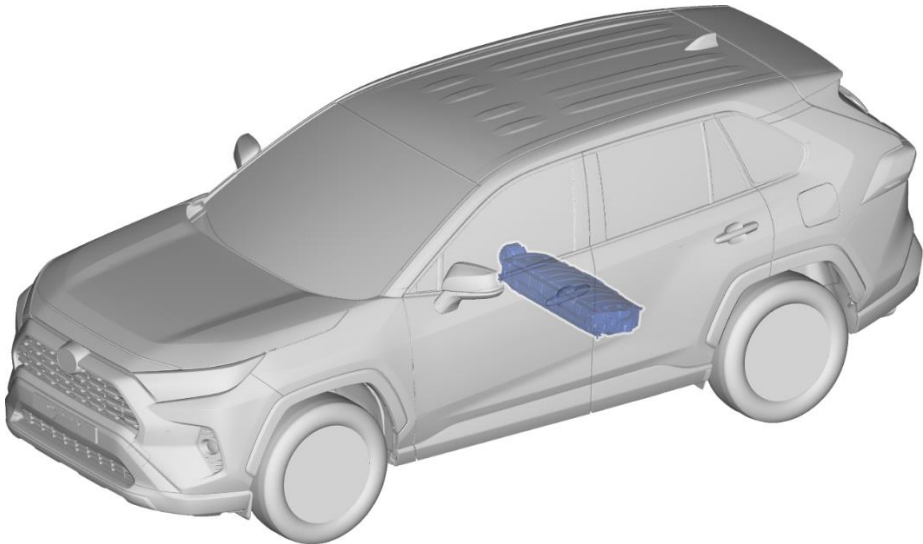
	 <p>Auxiliary Battery</p>
244.8 Volts HV Battery Pack	12 Volts Auxiliary Battery Mounted in Luggage Compartment Area (Right Side)
	
HV Battery Pack Mounted in Cabin Area	

## High Voltage Safety

The HV battery pack powers the high voltage electrical system with DC electricity. Positive and negative orange colored high voltage power cables are routed from the battery pack, under the vehicle floor pan, to the inverter/converter. The inverter/converter contains a circuit that boosts the HV battery voltage from 244.8 to 650 Volts DC. The inverter/converter creates 3-phase AC to power the motors. Power cables are routed from the inverter/converter to each high voltage motors (front and rear electric motors, electric generator, and A/C compressor). The following systems are intended to help keep occupants in the vehicle and emergency responders safe from high voltage electricity:

### High Voltage Safety System

- A high voltage fuse ❶\* provides short circuit protection in the HV battery pack.
- Positive and negative high voltage power cables ❷\* connected to the HV battery pack are controlled by 12 Volts normally open relays ❸\*. When the vehicle is shut off, the relays stop electricity flow from leaving the HV battery pack.



#### **WARNING:**

- ***The high voltage system may remain powered for up to 10 minutes after the vehicle is shut off or disabled. To prevent serious injury or death from severe burns or electric shock, avoid touching, cutting, or opening any orange high voltage power cable or high voltage component.***

- Both positive and negative power cables ❷\* are insulated from the metal body. High voltage electricity flows through these cables and not through the metal vehicle body. The metal vehicle body is safe to touch because it is insulated from the high voltage components.
- A ground fault monitor ❹\* continuously monitors for high voltage leakage to the metal chassis while the vehicle is running. If a malfunction is detected, the hybrid vehicle computer ❹\* will illuminate the master warning light  in the instrument cluster and a message indicating that the hybrid system is malfunctioning will be displayed on the multi-information display.
- The HV battery pack relays will automatically open to stop electricity flow in a collision sufficient to activate the SRS.

\*Numbers apply to the illustration on the following page.

## High Voltage Safety (Continued)

### Service Plug Grip

- The high voltage circuit is cut by removing the service plug grip (see page 15).

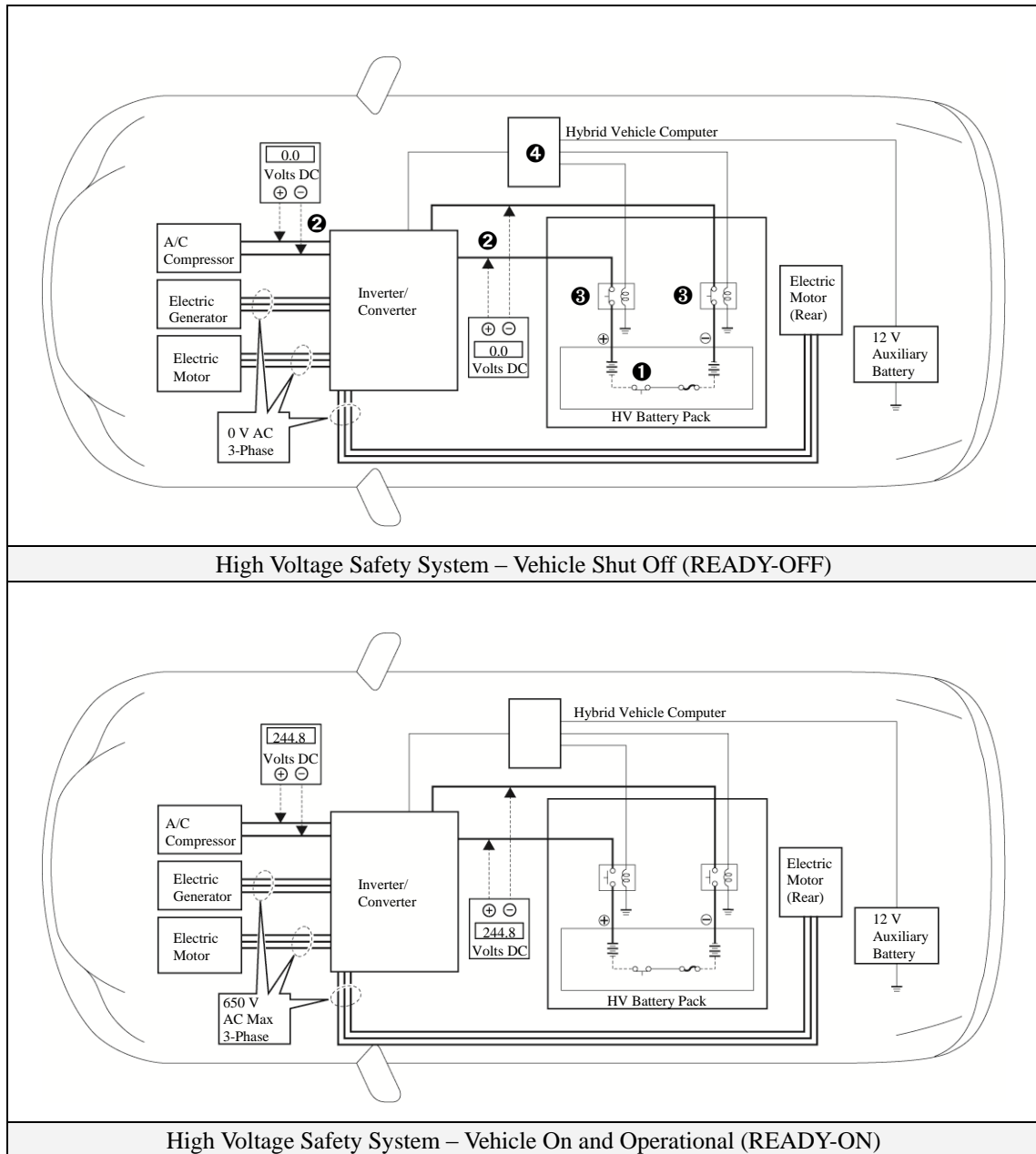



## Precaution to be observed when dismantling the vehicle



### **WARNING:**

- *The high voltage system may remain powered for up to 10 minutes after the vehicle is shut off or disabled. To prevent serious injury or death from severe burns or electric shock, avoid touching, cutting, or opening any orange high voltage power cable or high voltage component.*

### Necessary Items

- Protective clothing such as insulated gloves (electrically insulated), rubber gloves, safety goggles, and safety shoes.
- Insulating tape such as electrical tape that has a suitable electrical insulation rating.
- Before wearing insulated gloves, make sure that they are not cracked, ruptured, torn, or damaged in any way. Do not wear wet insulated gloves.
- An electrical tester that is capable of measuring DC 750 Volts or more.

## Spills

The RAV4 Hybrid contains the same common automotive fluids used in other non-hybrid Toyota vehicles, with the exception of the NiMH electrolyte used in the HV battery pack. The NiMH battery electrolyte is a caustic alkaline (pH 13.5) that is damaging to human tissues. The electrolyte, however, is absorbed in the cell plates and will not normally spill or leak out even if a metal battery module is cracked.

A catastrophic crash that would breach both the metal battery pack case and a metal battery module would be a rare occurrence.

A caustic alkaline is at the opposite end of the pH scale from a strong acid. A safe (neutral) substance is approximately in the middle of this scale. Adding a weak acidic mixture, such as a dilute boric acid solution or vinegar, to the caustic alkaline electrolyte will cause the electrolyte to be neutralized. This is similar but opposite to the use of baking soda to neutralize a lead-acid battery electrolyte spill.

- Handle NiMH electrolyte spills using the following Personal Protective Equipment (PPE):
  - Splash shield or safety goggles. A fold down face shield is not acceptable for acid or electrolyte spills.
  - Rubber, latex or nitrile gloves.
  - Apron suitable for alkaline.
  - Rubber boots.
  
- Neutralize NiMH electrolyte.
  - Use a boric acid solution or vinegar.
  - Boric acid solution - 800 grams boric acid to 20 liters water or 5.5 ounces boric acid to 1 gallon of water.

## Dismantling the vehicle

The following 5 pages contain general instructions for use when working on a RAV4 Hybrid. Read these instructions before proceeding to the HV battery removal instructions on page 20.



### **WARNING:**

- ***The high voltage system may remain powered for up to 10 minutes after the vehicle is shut off or disabled. To prevent serious injury or death from severe burns or electric shock, avoid touching, cutting, or opening any orange high voltage power cable or any high voltage component.***

1. Shut off the ignition (**READY** indicator is off).
2. REMOVE DECK BOARD ASSEMBLY
  - (1) Remove the deck board assembly.

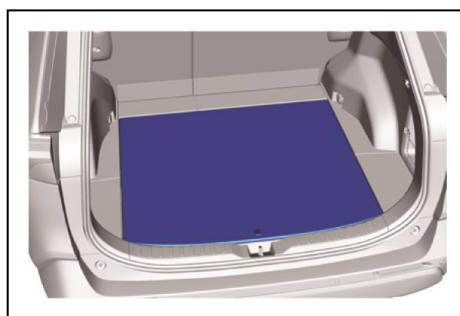

3. REMOVE REAR NO.2 FLOOR BOARD
  - (1) Detach the 2 clips and 2 guides and remove the rear No.2 floor board.

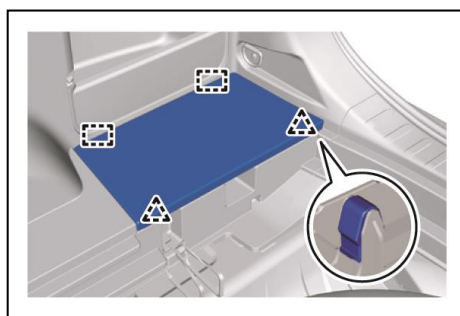

4. REMOVE BATTERY HOLE COVER
  - (1) Detach the 12 claws and remove the battery hole cover.

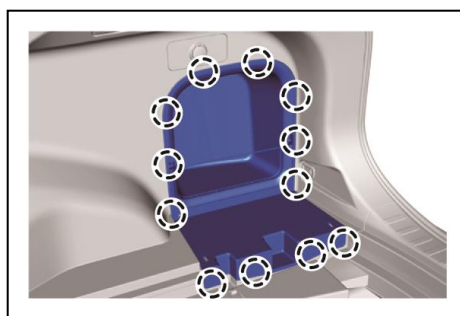

## 5. DISCONNECT CABLE FROM NEGATIVE AUXILIARY BATTERY TERMINAL

- (1) Loosen the nut, and disconnect the cable from the negative (-) auxiliary battery terminal.

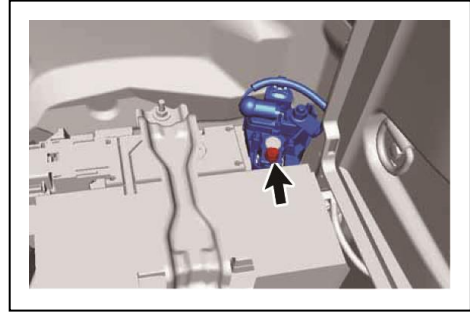

## 6. REMOVE BATTERY SERVICE HOLE COVER

- (1) Remove the clip.
- (2) Disengage the 8 claws as shown in the illustration.

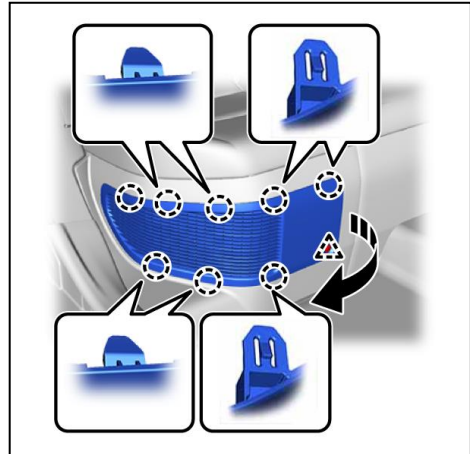

- (3) Disengage the guide to remove the battery service hole cover as shown in the illustration.

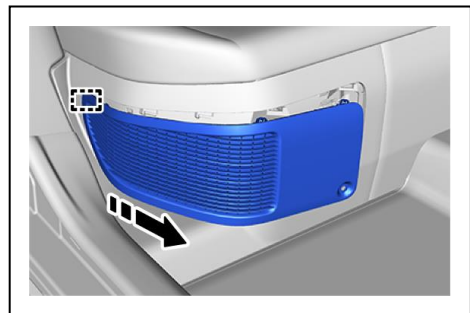

## 7. REMOVE SERVICE PLUG GRIP

### CAUTION:

- Be sure to wear insulated gloves.
- Do not inspect or service the high voltage system with the service plug grip installed.
- To reduce the risk of electric shock, make sure to remove the service plug grip to cut off the high voltage circuit before servicing the vehicle.

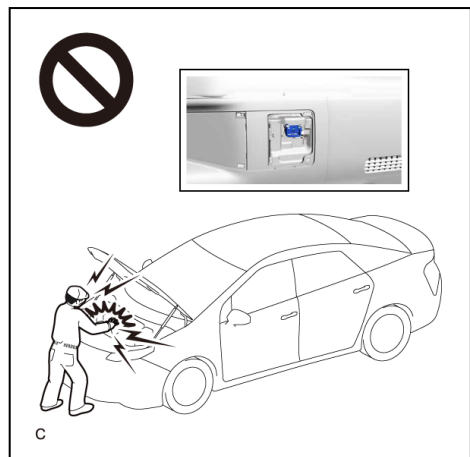

- To reduce the risk of electric shock, make sure to wait at least 10 minutes after removing the service plug grip to fully discharge the high voltage capacitor inside the inverter with converter assembly.
- Keep the removed service plug grip in your pocket to prevent other technicians from accidentally installing it while you are servicing the vehicle.

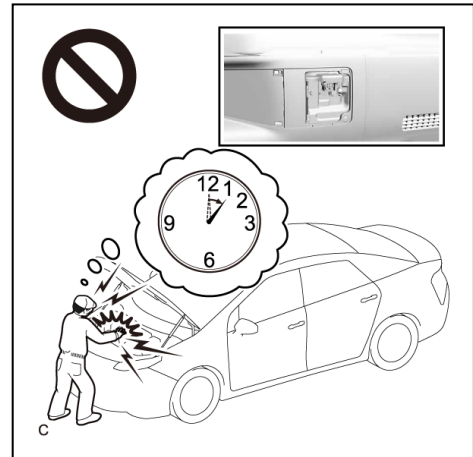

**NOTICE:**

- After removing the service plug grip, turning the power switch on (READY) may cause a malfunction. Do not turn the power switch on (READY) unless instructed by the repair manual.
- Do not touch the terminals of the service plug grip.

**HINT:**

Waiting for at least 10 minutes is required to discharge the high voltage capacitor inside the inverter with converter assembly.

- (1) While wearing insulated gloves, rotate the handle of the service plug grip and remove the service plug grip as indicated by the arrows, in the order shown in the illustration.

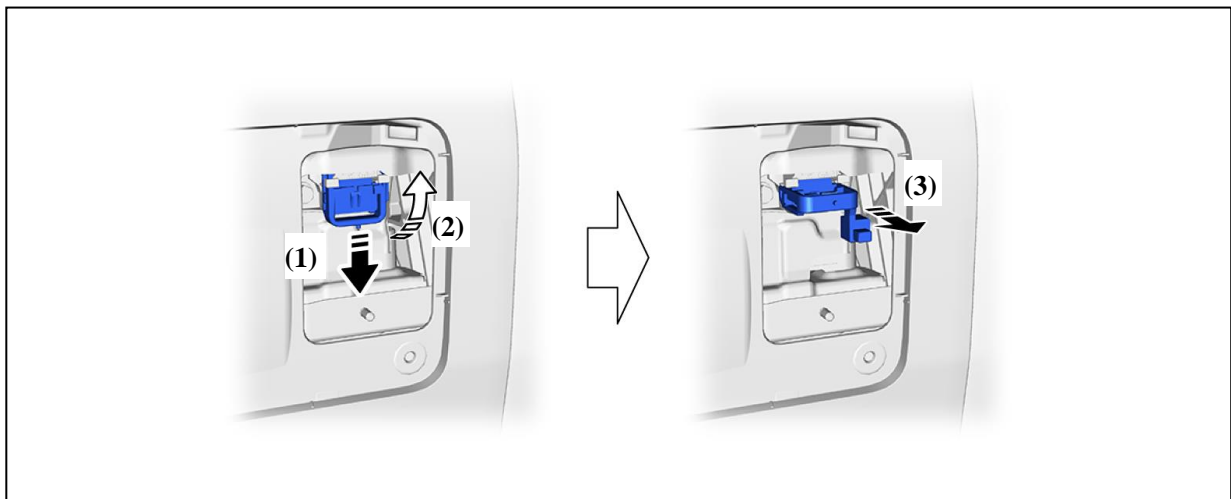

8. Make other staff aware that a high-voltage system is being dismantled by using the following sign: CAUTION: HIGH-VOLTAGE. DO NOT TOUCH (see page 19).

9. If the service plug grip cannot be removed due to damage to the vehicle, remove the **IGCT NO.2** fuse (10 A).

**CAUTION:**

**This operation shuts off the HV system. Be sure to wear insulated gloves because high voltage is not shut off inside the HV battery. When it is possible to remove the service plug grip, remove it and continue the procedure.**

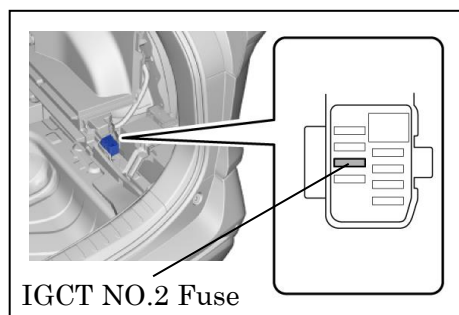

10. After disconnecting or exposing a high-voltage connector or terminal, insulate it immediately using insulating tape. Before disconnecting or touching a bare high-voltage terminal, wear insulated gloves.
11. Check the HV battery and nearby area for leakage. If you find any liquid, it may be strong alkaline electrolyte. Wear rubber gloves and goggles and neutralize the liquid using a saturated boric acid solution or vinegar. Then wipe up the liquid using waste rags etc.
12. If the electrolyte comes into contact with your skin, wash the skin immediately using a saturated boric acid solution or a large amount of water. If the electrolyte adheres to any article of clothing, take the clothing off immediately.
13. If the electrolyte comes into contact with your eye(s), call out loudly for help. Do not rub your eye(s). Instead, wash the eye(s) with a dilute boric acid solution or a large amount of water and seek medical care.
14. With the exception of the HV battery, remove parts by following procedures which are similar to conventional Toyota vehicles. For the removal of the HV battery, refer to the following pages.

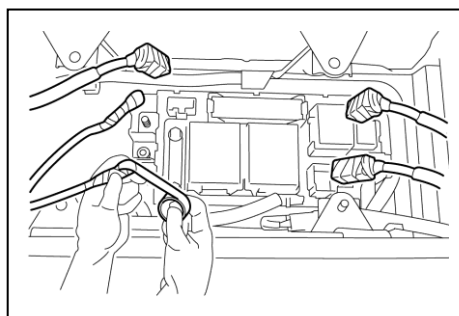

Person in charge: \_\_\_\_\_

**CAUTION:**  
**HIGH-VOLTAGE.**  
**DO NOT TOUCH.**

**CAUTION:**  
**HIGH-VOLTAGE.**  
**DO NOT TOUCH.**

Person in charge: \_\_\_\_\_

When performing work on the HV system, fold this sign and put it on the roof of the vehicle.

## Removal of HV battery



### **WARNING:**

- *Be sure to wear insulated gloves when handling high-voltage parts.*
- *Even if the vehicle is shut off and the relays are off, be sure to remove the service plug grip before performing any further work.*
- *Power remains in the high voltage electrical system for 10 minutes even after the HV battery pack is shut off because the circuit has a condenser that stores power.*
- *Make sure that the tester reading is 0 V before touching any high-voltage terminals which are not insulated.*
- *The SRS may remain powered for up to 90 seconds after the vehicle is shut off or disabled. To prevent serious injury or death from unintentional SRS deployment, avoid cutting the SRS components.*

1. SHUT OFF IGINATION (**READY** indicator is off)

2. REMOVE DECK BOARD ASSEMBLY

- (1) Remove the deck board assembly.

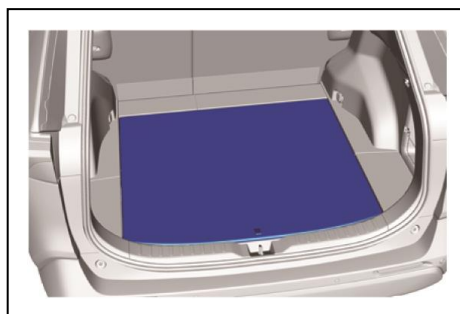

3. REMOVE REAR NO.2 FLOOR BOARD

- (1) Detach the 2 clips and 2 guides and remove the rear No.2 floor board.

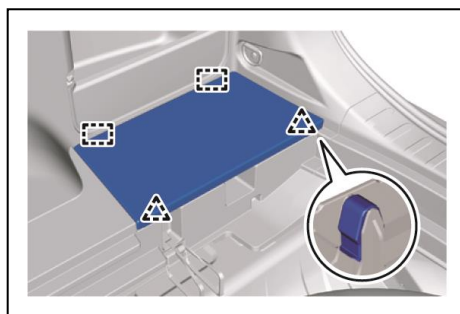



#### 4. REMOVE BATTERY HOLE COVER

- (1) Detach the 12 claws and remove the battery hole cover.

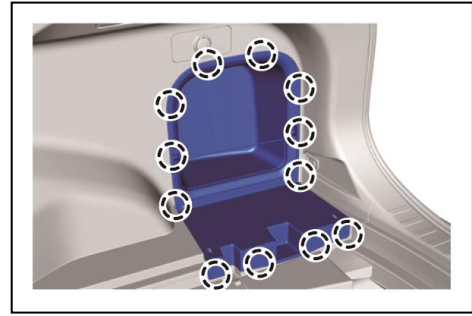

#### 5. DISCONNECT CABLE FROM NEGATIVE AUXILIARY BATTERY TERMINAL

- (1) Loosen the nut, and disconnect the cable from the negative (-) auxiliary battery terminal.

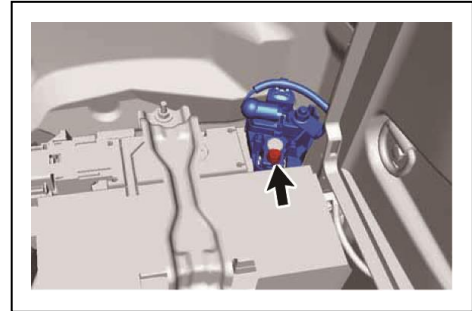

#### 6. REMOVE BATTERY SERVICE HOLE COVER

- (1) Remove the clip.
- (2) Disengage the 8 claws as shown in the illustration.

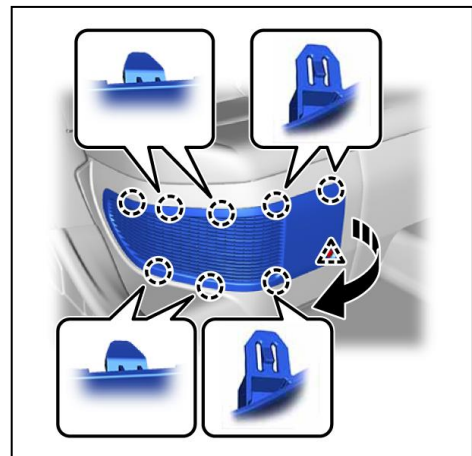

- (3) Disengage the guide to remove the battery service hole cover as shown in the illustration.

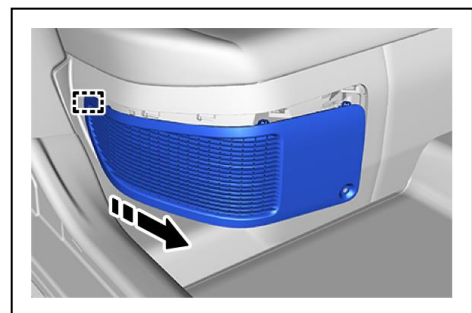

## 7. REMOVE SERVICE PLUG GRIP

### CAUTION:

- Be sure to wear insulated gloves.
- Do not inspect or service the high voltage system with the service plug grip installed.
- To reduce the risk of electric shock, make sure to remove the service plug grip to cut off the high voltage circuit before servicing the vehicle.



- To reduce the risk of electric shock, make sure to wait at least 10 minutes after removing the service plug grip to fully discharge the high voltage capacitor inside the inverter with converter assembly.
- Keep the removed service plug grip in your pocket to prevent other technicians from accidentally installing it while you are servicing the vehicle.

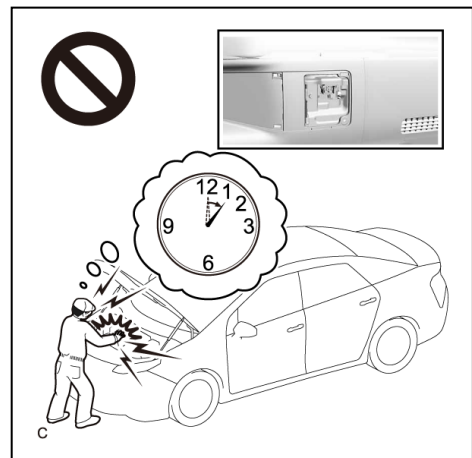

### NOTICE:

- After removing the service plug grip, turning the power switch on (READY) may cause a malfunction. Do not turn the power switch on (READY) unless instructed by the repair manual.
- Do not touch the terminals of the service plug grip.

### HINT:

Waiting for at least 10 minutes is required to discharge the high voltage capacitor inside the inverter with converter assembly.

- (1) While wearing insulated gloves, rotate the handle of the service plug grip and remove the service plug grip as indicated by the arrows, in the order shown in the illustration.

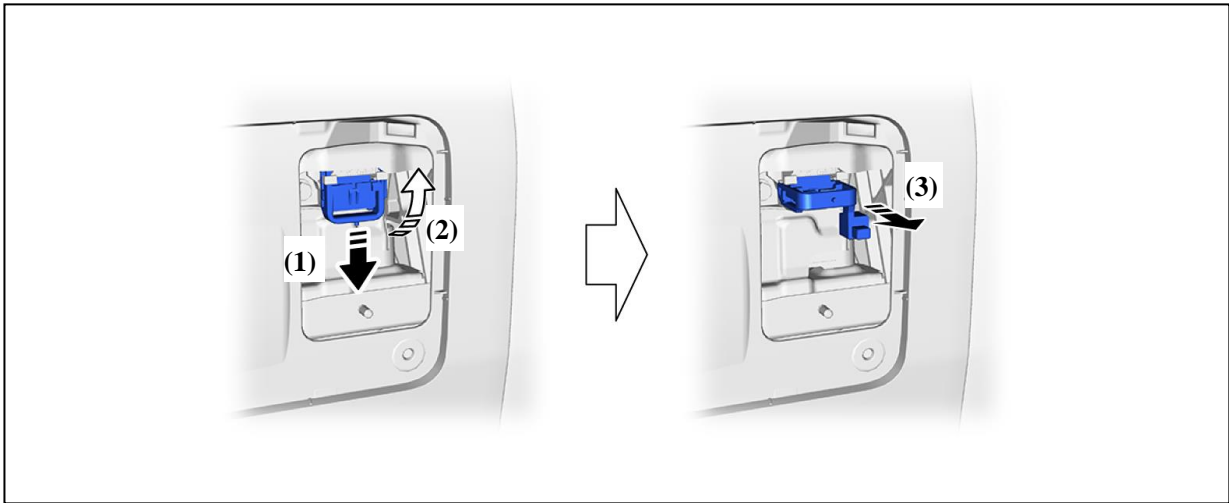

#### 8. DISCONNECT ENGINE ROOM MAIN WIRE

**CAUTION:**

**Be sure to wear insulated gloves.**

**NOTICE:**

Do not allow any foreign matter or water to enter the inverter with converter assembly.

- (1) Move the lock lever while pushing the lock on the connector, and disconnect the inverter with converter assembly connector.
- (2)

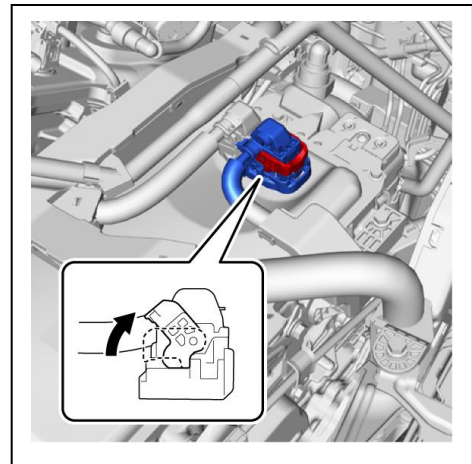

#### 9. REMOVE CONNECTOR COVER ASSEMBLY

**CAUTION:**

**Be sure to wear insulated gloves.**

- (1) Remove the bolt (B).
- (2) Using a T25 "TORX" socket wrench, remove the bolt (A) and connector cover assembly from the inverter with converter assembly.

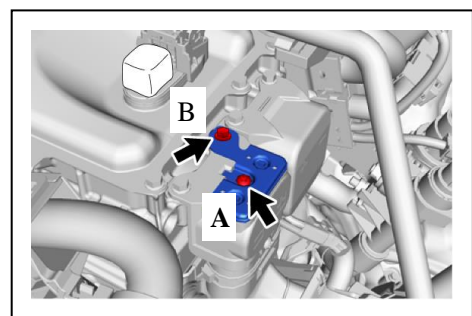

**NOTICE:**

- Do not touch the connector cover assembly waterproof seal.
- Do not allow any foreign matter or water to enter the inverter with converter assembly.

## 10. CHECK TERMINAL VOLTAGE

### CAUTION:

**Be sure to wear insulated gloves.**

- (1) Using a voltmeter, measure the voltage between the terminals of the 2 phase connectors.

**Standard voltage: 0 V**

### NOTICE:

Do not allow any foreign matter or water to enter the inverter with converter assembly.

### HINT:

Use a measuring range of DC 750 V or more on the voltmeter.

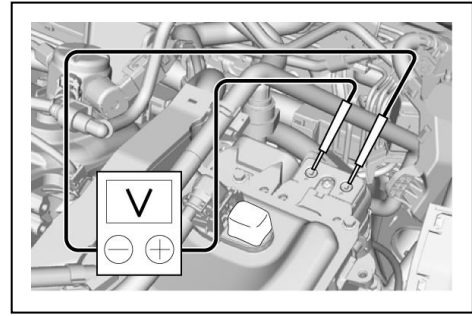

## 11. REMOVE BENCH TYPE REAR SEAT CUSHION ASSEMBLY

- (1) Place your hand in the position shown in the illustration and lift the front end of bench type rear seat cushion assembly in the removal direction to detach the hook on the front of bench type rear seat cushion assembly from the rear seat cushion lock hook.

### NOTICE:

- Be sure to detach the hook on the front of bench type rear seat cushion assembly one at a time.

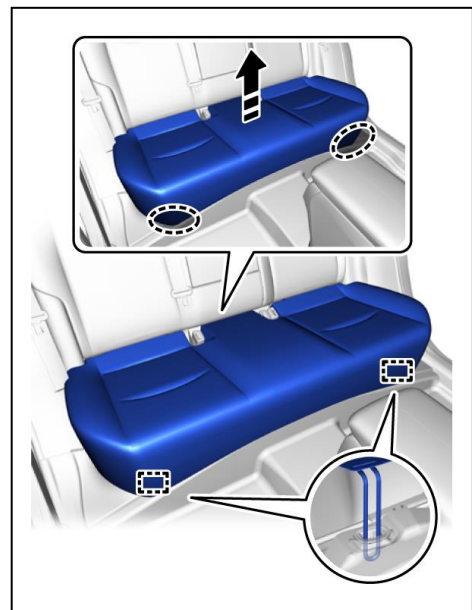

- (2) Place your hand in the position shown in the illustration and pull in the removal direction to detach the hook on the rear end of bench type rear seat cushion assembly.

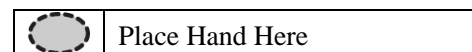
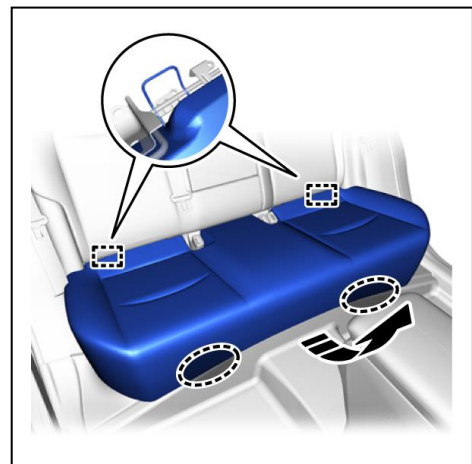

- (3) w/ Occupant Detection Sensor:
  - (i) Disconnect the 3 connectors for occupant detection sensor.
- (4) w/ Seat Heater System:
  - (i) Disconnect the 4 connectors for seat heater.
- (5) Remove the bench type rear seat cushion assembly.

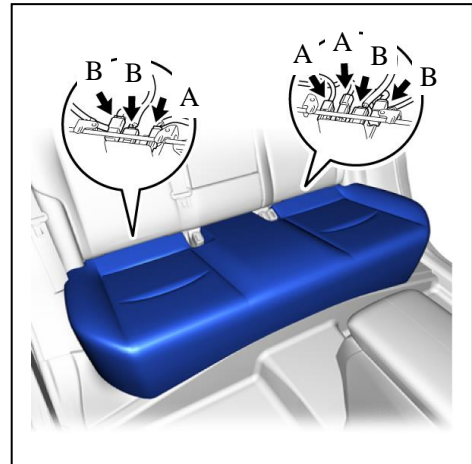

A	w/ Occupant Detection Sensor
B	w/ Seat Heater System

## 12. REMOVE REAR DOOR SCUFF PLATE LH

- (1) Place your hand at the position shown in the illustration and pull in the removal direction to detach the 2 claws and guide.

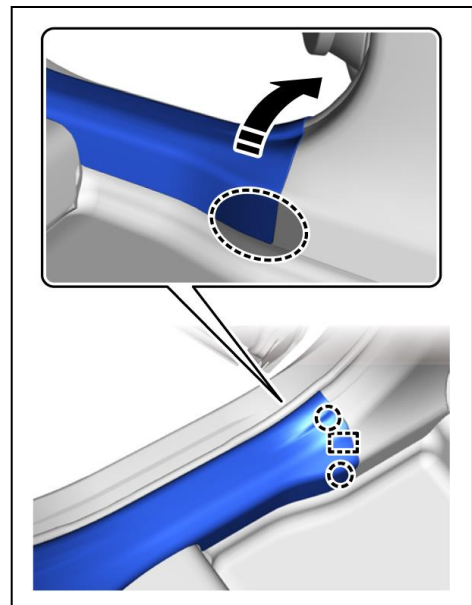

	Place Hand Here
--	-----------------

- (2) Place both hands at the position shown in the illustration and lift in the direction indicated by the arrow to detach the 2 claws, clip and 3 guides and remove the rear door scuff plate LH.

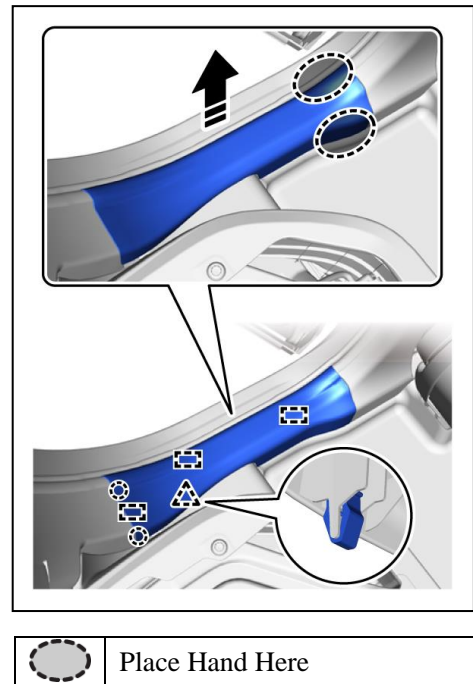

### 13. REMOVE NO. 3 BATTERY SERVICE COVER BOARD

- (1) Remove the 2 clips (A).
- (2) Disengage the 3 clips (B), 2 clips (C) and guide to remove the No. 3 battery service cover board.

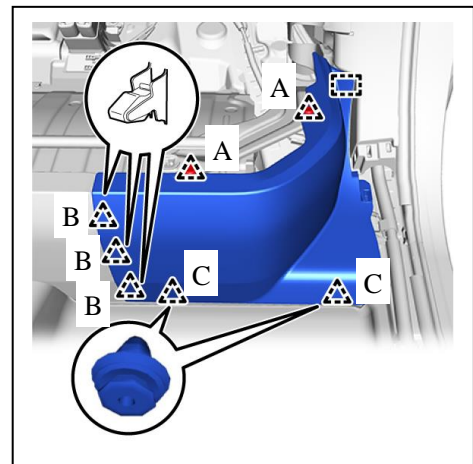

### 14. REMOVE REAR DOOR SCUFF PLATE RH

**HINT:**

Use the same procedure described for the LH side.



### 15. REMOVE NO. 2 BATTERY SERVICE COVER BOARD

- (1) Remove the 2 clips (A).
- (2) Disengage the 3 clips (B), 2 clips (C) and guide to remove the No. 2 battery service cover board.

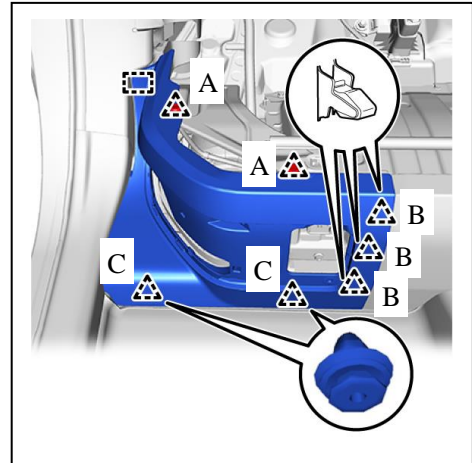

### 16. REMOVE BATTERY SERVICE COVER BOARD

- (1) Pull the rear under cover in the direction indicated by the arrow (1) shown in the illustration to disengage the 2 clips.
- (2) Pull the battery service cover board in the direction indicated by the arrow (2) shown in the illustration to disengage the 2 guides to remove it from the rear seat cushion leg sub-assembly.

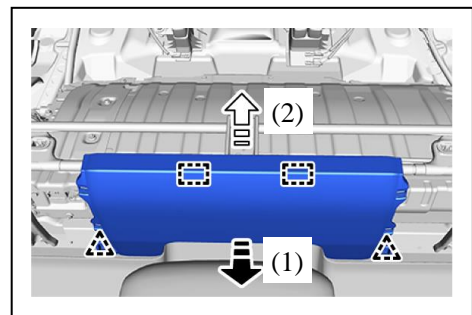

### 17. REMOVE REAR SEAT CUSHION LEG SUB-ASSEMBLY

- (1) Remove the 6 bolts.
- (2) Pull in the direction of the arrow in the illustration and detach the 2 guides and remove the rear seat cushion leg sub-assembly.

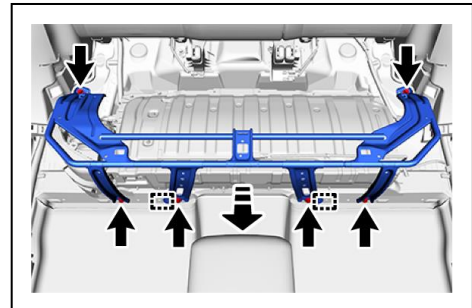

### 18. REMOVE NO. 1 HYBRID BATTERY INTAKE DUCT

- (1) Disengage the 2 clamps.

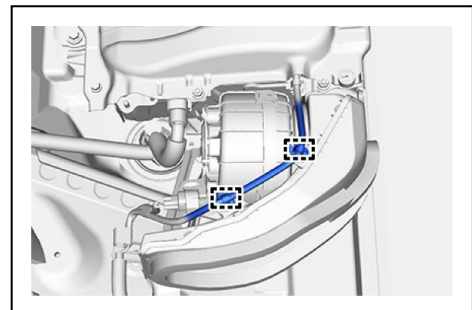

- (2) Remove the 2 clips and No. 1 hybrid battery intake duct from the battery cooling blower assembly.

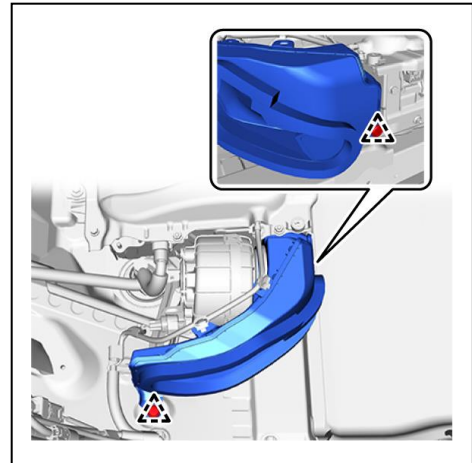

### 19. REMOVE BATTERY COOLING BLOWER ASSEMBLY

- (1) Disconnect the battery cooling blower assembly connector.

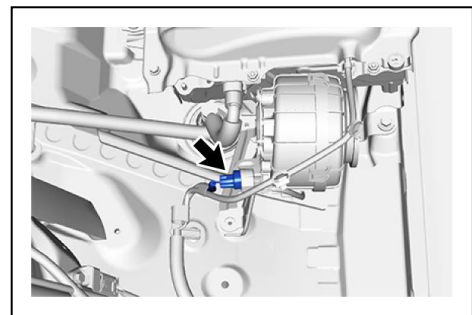

- (2) Remove the 2 bolts and battery cooling blower assembly from the HV battery.

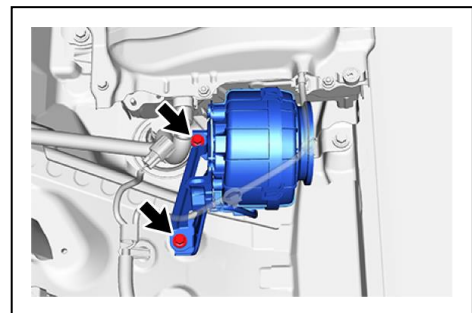



20. REMOVE NO. 1 HV BATTERY COVER PANEL RH

**CAUTION:**

**Be sure to wear insulated gloves.**

- (1) Using the service plug grip, remove the battery over lock striker.

**HINT:**

Insert the projection of the service plug grip and urn the button of the battery cover lock striker counterclockwise to release the lock.

- (2) Remove the 3 bolts, 3 nuts and No. 1 HV battery cover panel RH from the HV battery.

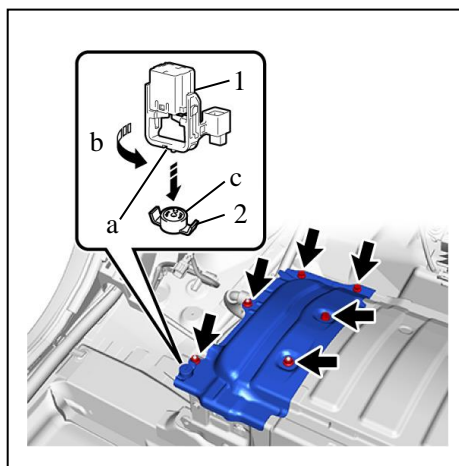

1	Service Plug Grip
2	Battery Cover Lock Striker
a	Projection
b	Turn
c	Button

21. DISCONNECT HV FLOOR UNDER WIRE

**CAUTION:**

**Be sure to wear insulated gloves.**

- (1) Disconnect the 2 HV battery junction block assembly connectors.

**NOTICE:**

Insulate each disconnected high-voltage connector with insulating tape. Wrap the connector from the wire harness side to the end of the connector.

- (2) Disconnect the shield ground from the HV battery.

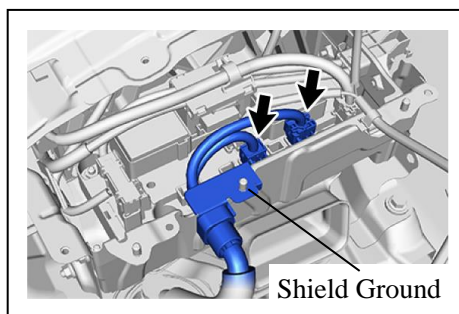

22. DISCONNECT FLOOR WIRE

**CAUTION:**

**Be sure to wear insulated gloves.**

- (1) Disengage the clamp.
- (2) Disconnect the electric vehicle battery plug assembly connector.
- (3) Disconnect the HV battery junction block assembly connector.

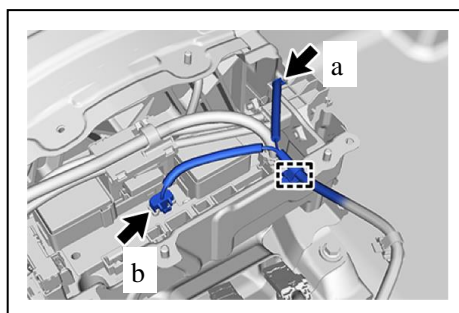

a	Electric Vehicle Battery Plug Assembly Connector
b	HV Battery Junction Block Assembly Connector

### 23. REMOVE NO. 1 INDOOR ELECTRICAL KEY ANTENNA ASSEMBLY

- (1) Disconnect the connector.
- (2) Detach the clamp and remove the No. 1 indoor electrical key antenna assembly.

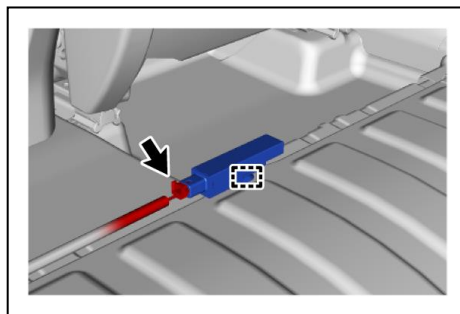

### 24. DISCONNECT FLOOR WIRE

**CAUTION:**

**Be sure to wear insulated gloves.**

- (1) Disengage the 2 clamps to disconnect the floor wire.

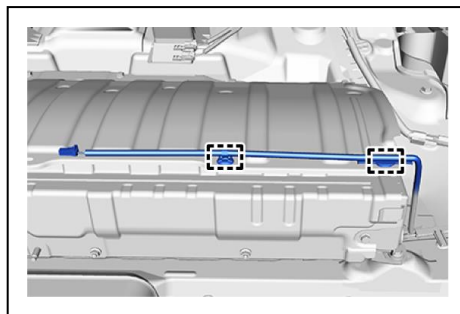

### 25. REMOVE NO. 1 HYBRID BATTERY EXHAUST DUCT

**CAUTION:**

**Be sure to wear insulated gloves.**

- (1) Remove the clip.
- (2) Disengage the claw to remove the No. 1 hybrid battery exhaust duct from the HV battery.

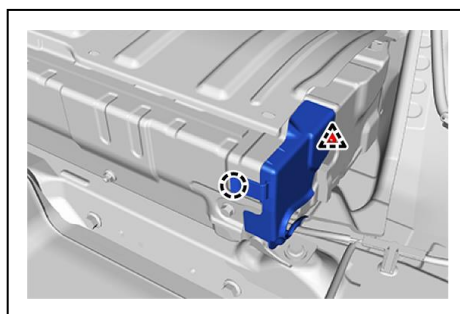

### 26. DISCONNECT FLOOR WIRE

**CAUTION:**

**Be sure to wear insulated gloves.**

- (1) Disconnect the battery voltage sensor connector.

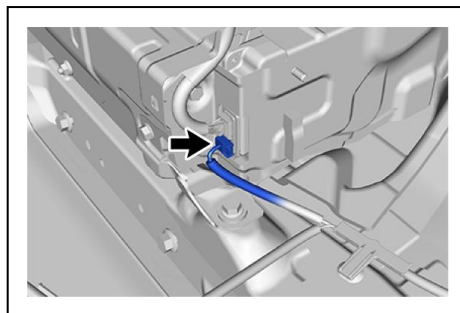

## 27. REMOVE HV BATTERY

### **CAUTION:**

**Be sure to wear insulated gloves.**

- (1) Remove the 5 bolts and HV battery from the vehicle body.

### **NOTICE:**

- Do not allow foreign matter, such as grease or oil, to adhere to the bolts of the HV battery.
- To prevent the wire harness from being caught, make sure to bundle the wire harness using insulating tape or equivalent.
- Use cardboard or another similar material to protect the HV battery and vehicle body from damage.
- Since the HV battery is very heavy, 2 people are needed to remove it. When removing the HV battery, be careful not to damage the parts around it.
- When removing the HV battery from the vehicle, do not allow it to contact the vehicle.
- When removing/installing/moving the HV battery, make sure not to tilt it more than 80°.
- Insulate the disconnected terminals or connectors with insulating tape.

